

How to build compliant

# SPANDREL PANELS

Guidance on building and installing spandrel panels  
for party walls above masonry



Version 3  
April 2018

# Foreword



Today many builders are exploring the efficiencies and quality benefits of pre-manufacturing and offsite construction. As part of this drive, builders increasingly use timber spandrel panels in low-rise housing and apartments.

The advantages of using spandrel panels are numerous, but six key benefits stand out:

- The panels can be manufactured off-site
- They help to improve on-site safety, as they require less time working at height
- They can be installed quickly
- Faster installation times mean lower costs
- They leave little or no site waste
- Using spandrel panels can help to address the shortage of skills on-site

To ensure safe and effective working practices, this document sets out some essential guidance on various aspects of spandrel panel design, construction and installation.

In particular, the guide aims to provide evidence-based, consistent information on best practice for spandrel panel usage in party walls above masonry.

The guidance has been prepared collaboratively by the Trussed Rafter Association and the Structural Timber Association, and in cooperation with the NHBC.



"As the housebuilding industry moves evermore towards innovative methods of construction, it is encouraging to see the supply chain embracing the challenges and ensuring that products perform as expected.

"This document represents a first significant step towards standardising this innovative method of construction."

**Paul Cribbens, NHBC Standards Manager**

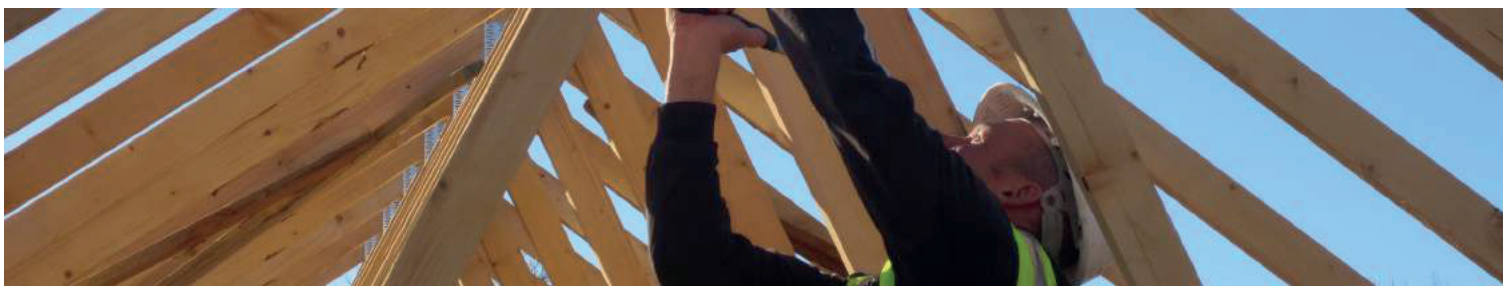



# Contents



01. Design p. 04

02. Structural requirements p. 05

03. Fire resistance p. 09

04. Panel construction p. 10

05. Single-skin cladding p. 11

06. Weather protection p. 12

07. Safe installation p. 13



# 01

## Design

For masonry separating walls, Robust Details' Handbook notes in Appendix A1: "Where stated in the Robust Detail spandrel panels are an acceptable alternative to building the cavity separating wall in the roof space (without room-in-roof)."

### Acoustic performance

Appendix A1 provides a generic spandrel panel specification to maintain acoustic integrity between dwellings. It recognises spandrels need to comply with Building Regulations Part B for fire compartments, but does not provide specific construction details such as specifications, fixing arrangements or interface details.

Robust Details requires both leaves of blockwork to extend a minimum of 300mm above ceiling, and the cavity to be stopped.

Information in this guide provides good practice examples of how these additional issues may be addressed in terms of masonry construction. It is also important to recognise alternative solutions have been developed outside of Robust Details.

### Single-piece panels

Single-piece party wall spandrel panels are recommended wherever possible in order to minimise working at height, to maintain build quality and to ensure integrity of fire compartments.

Before splitting a panel, consider additional blockwork course(s) above 300mm minimum or increase the size or grade of members within the softwood structural frame.

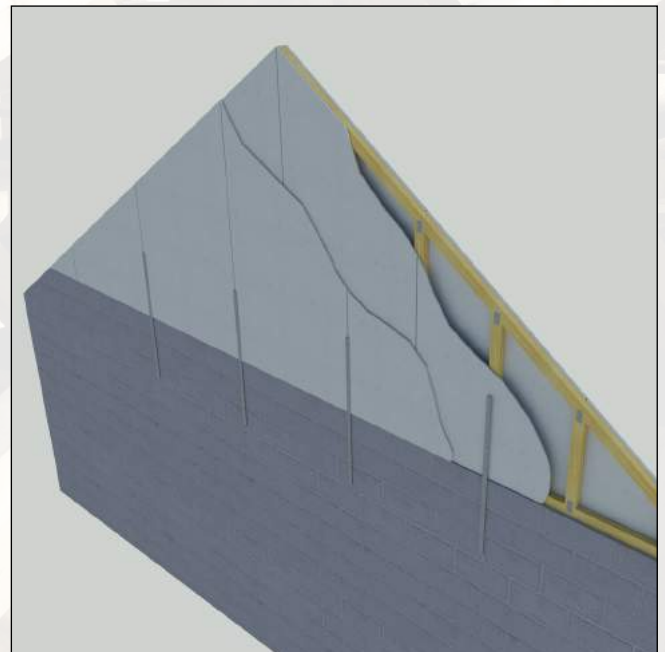
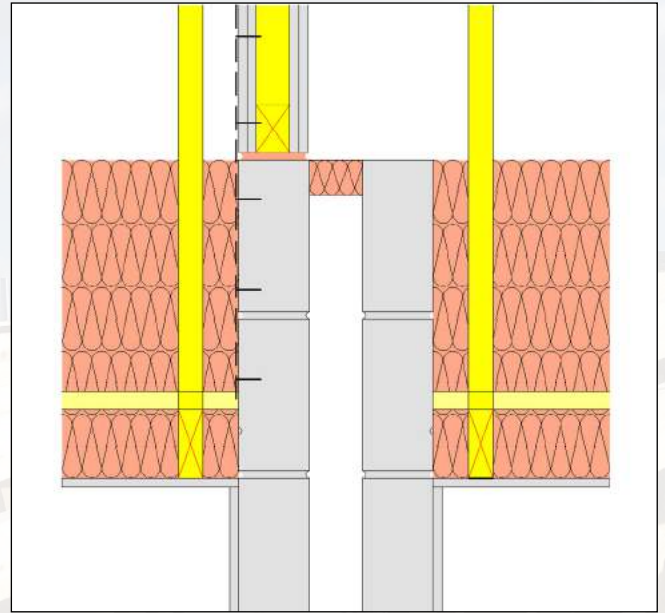

# 02

## Structural requirements

### Panel support



Party wall spandrels provide a separating function but are non-load bearing.

However, robust lateral connections to the roof trusses on either side of the panel are essential to maintain stability if the panel is subject to fire. This is particularly important if a fire weakens the support on one side of the panel.

Therefore it is essential that the bottom chord of the panel is fully supported throughout its length.

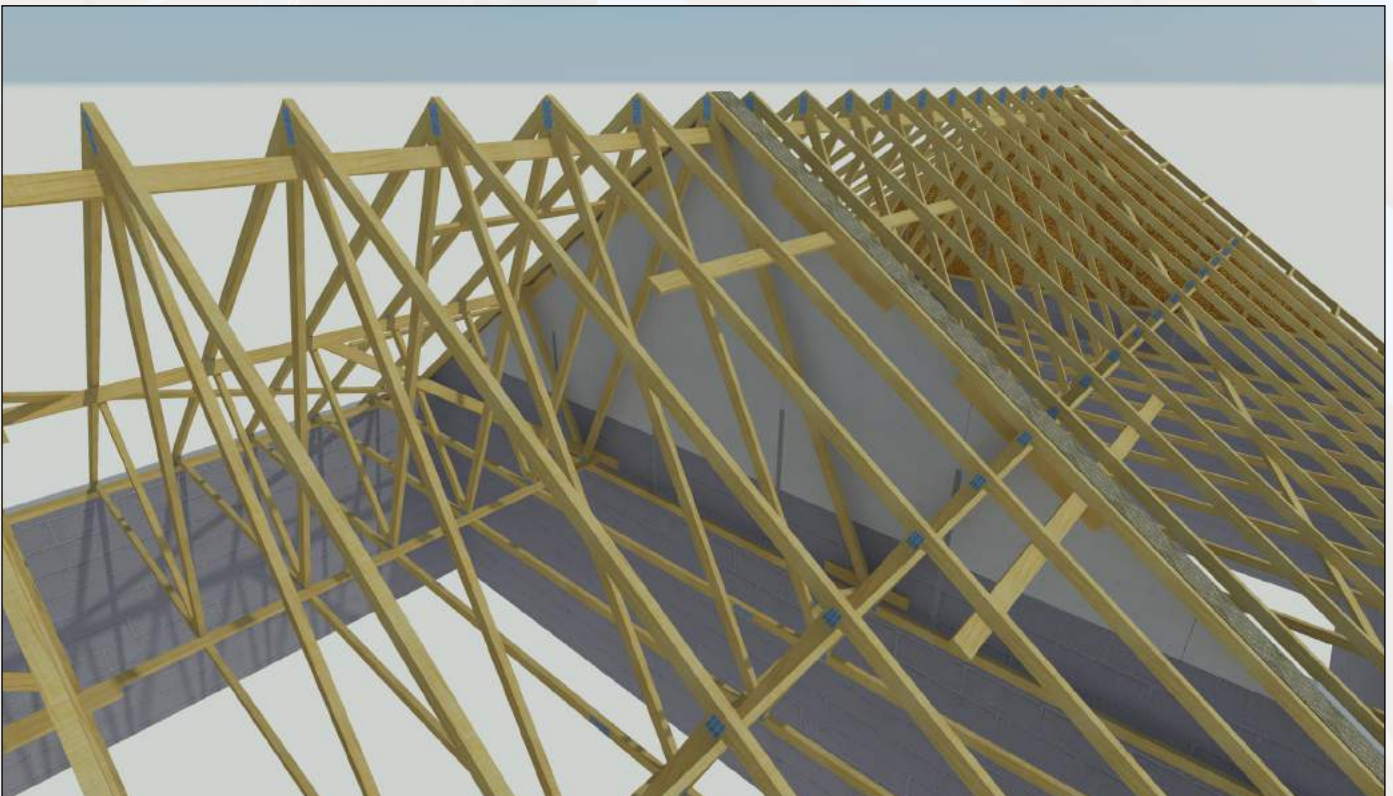



# 02 Structural requirements

## Head detail

Head restraint may be achieved through timber bracing. Requirements for the spandrel panel head restraint are as follows:

- Lateral bracing at maximum two-metre centres
- Minimum bracing section 25 x 100mm, fixed using 2 x 3.35 x 65mm galvanised wire nails to top edge of the timber ledger
- Minimum section 45 x 72mm and minimum length 900mm
- Timber ledger screw-fixed with minimum 100mm-long screws to at least two vertical studs within the panel
- Lateral bracing to be fixed to a minimum of three trusses. (Note: 3.1mm machine nails may be used in lieu of 3.35mm standard wire nails)



## Example

- Spandrel head at a minimum of 50mm below the truss head
- 60mm layer of mineral wool placed below the underlay felt as a fire stop. Fireproofing should continue into any boxed eaves
- Tiles positioned on BS 5534 battens
- 60mm layer of mineral wool quilt placed above underlay felt and laid between battens from eaves to ridge

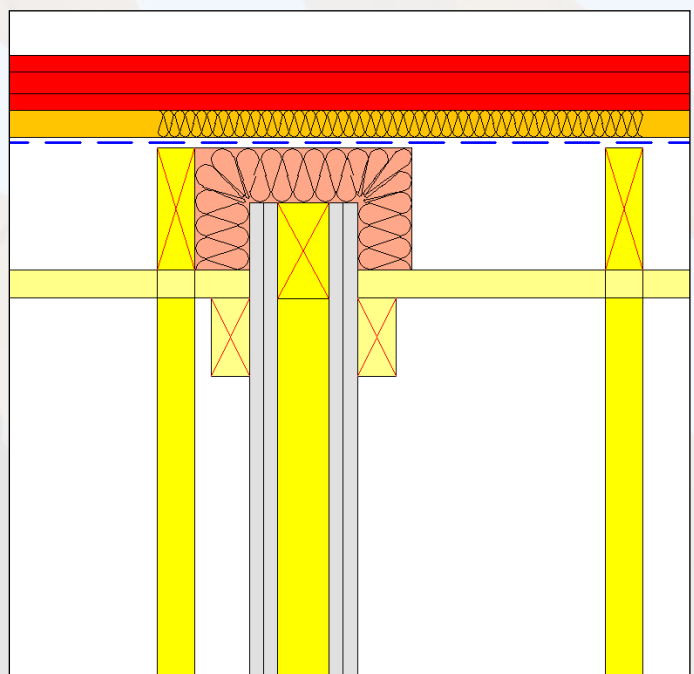

# 02 Structural requirements

## Alternative head detail

Head restraint may also be achieved through metal restraint straps. Requirements for the spandrel panel head restraint are as follows:

- Lateral bracing to be fitted at apex and along rafters and ceiling joists maximum two-metre centres (no more than 1.25m centres for dwellings over three storeys or over two storeys in Scotland)
- Minimum 38mm x 63mm noggings fixed between at least three trusses
- Metal restraint strap fixed to noggings with eight 3.75mm x 30mm square twisted nails evenly spaced
- End of metal restraint strap to be screw-fixed to studwork within spandrel with minimum 65mm-long screws



## Example

- Spandrel head at a minimum of 50mm below the truss head
- 60mm layer of mineral wool placed below the underlay felt as a fire stop. Fireproofing should continue into any boxed eaves
- Tiles positioned on BS 5534 battens
- 60mm layer of mineral wool quilt placed above underlay felt and laid between battens from eaves to ridge

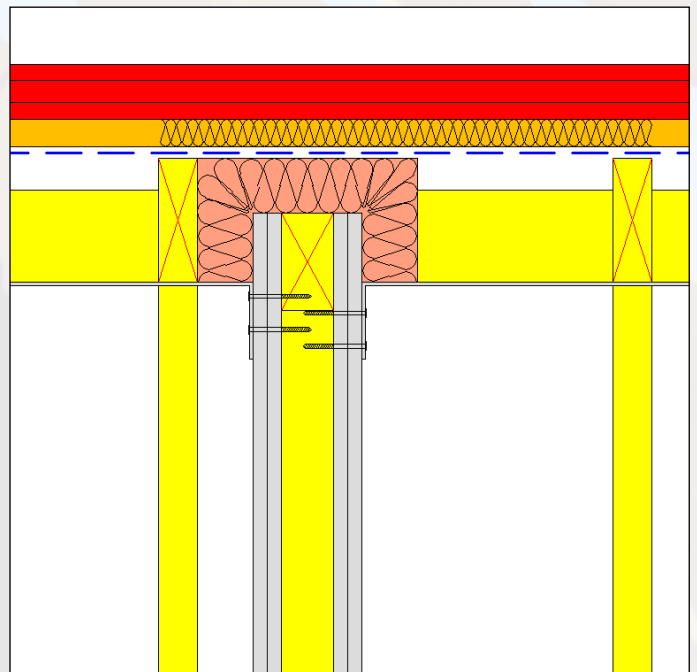



# 02 Structural requirements

## Foot detail

Requirements for the base of the spandrel panel are as follows:

- Blockwork must provide continuous support to the bottom edge of the panel, at a minimum of 300mm above ceiling
- This may extend higher to allow for full-height courses, single-piece panels or to minimise thermal bridging
- A level finish, free of excess mortar is required
- Cavity sealed with a flexible fire stop
- The example in Robust Details' Handbook Appendix A1 shows timber sitting directly on blockwork, with flexible sealant between board lining and blockwork

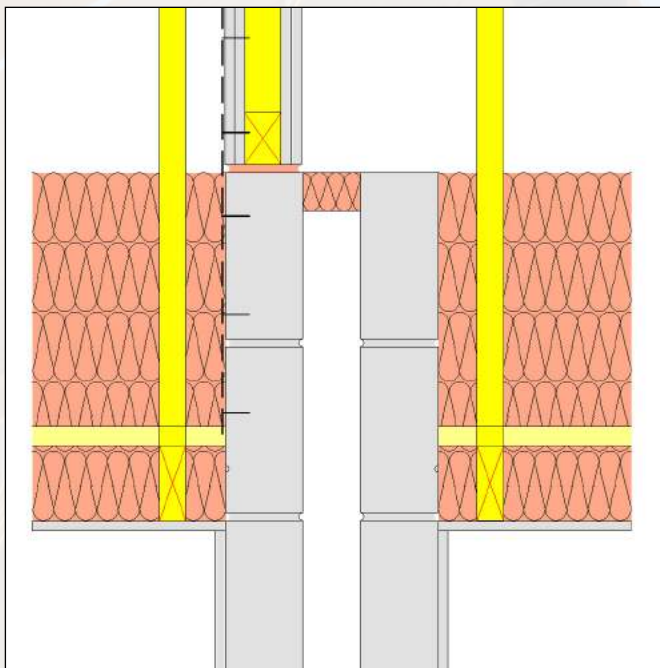
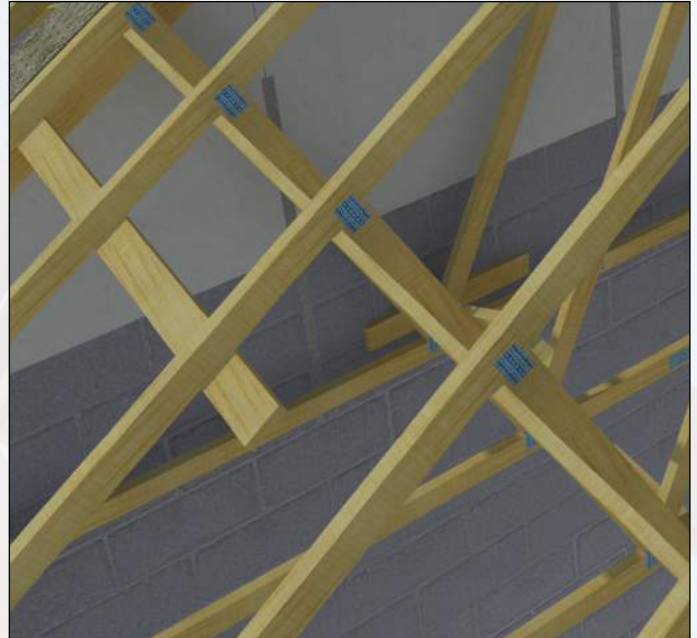

## Example

- Bottom edge of the panel sealed with compressible mineral wool fibre pad
- This is both visible for inspection and able to fill any gaps due to tolerances between the supporting masonry wall and spandrel panel
- Holding down straps are necessary to ensure the panel can resist lateral forces
- Straps at 1200mm centres, face-fixed to coincide with alternate stud positions
- The strap length should ensure two good screw fixings into the panel framework (65mm screws) and a minimum of three plug and screw fixings into at least two blocks



# 03

## Fire resistance

### Panel connections

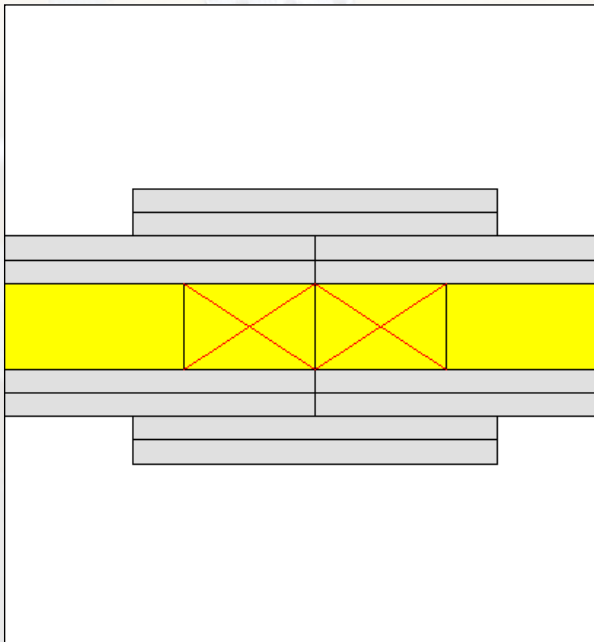

According to the calculation method in Annex E of BS EN 1995-1-2, joints in the dry lining do not influence the separating performance of the wall if they are backed with a batten or a structural element.

If the joints aren't backed in one of these ways, a reduction factor must be applied, as per Clause E2.1(1).

If the installation of a single-piece party wall spandrel panel is not possible and joints between panels are necessary, the vertical joint shown in the illustration opposite is an example of a joint currently in use.

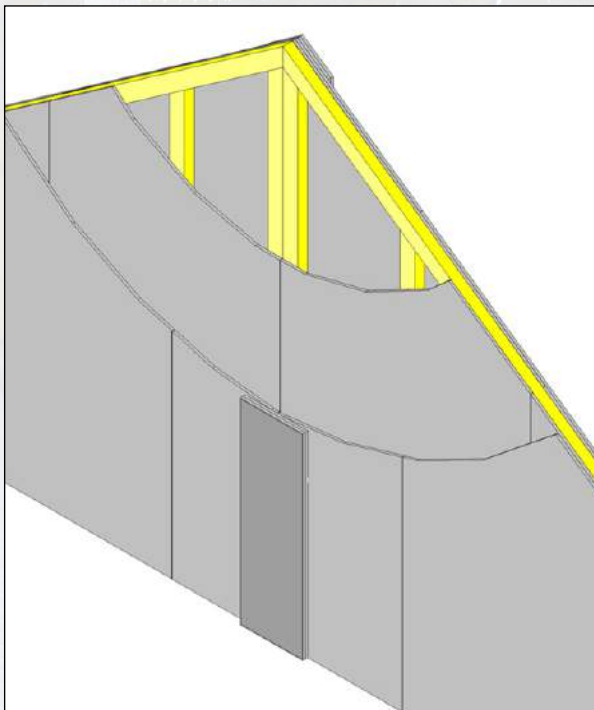

In this example, the panels are butt jointed and covered by cover strips, which are site applied and designed to replicate cladding over the joint.

The cover strip minimum width is 150mm, fixed to both studs using fixings and schedule as per the original cladding.

For twin cladding layers, the joints must be staggered and be positioned directly over the studs.

Plasterboard screw fixings into 47mm studs should penetrate the timber by a minimum of 25mm. The standard fixing pattern for plasterboard into timber is 300mm max centres.

It is recommended that each cover strip is fixed independently and the screw fixings are staggered between layers. Any joints in the two layers of cover strip should also be staggered.

# 04

## Panel construction

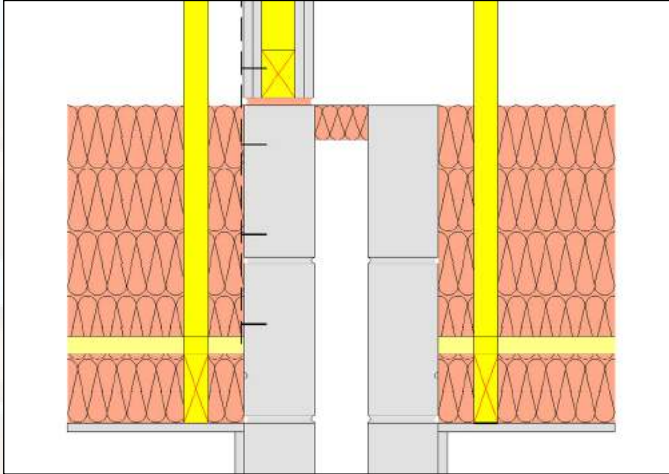

### Structural integrity

- Engineering to be supported by design software and structural calculations, to confirm the structural integrity of the panel during delivery, crane handling and site installation. This includes nailed joint specifications
- Panels are supplied with factory-fitted, weight-tested lifting straps suitable for the condition in which they are delivered. Weight to be clearly marked on the panel
- Offsite manufacture is subject to third-party accredited, quality assured Factory Production Control

### Building the frame

The requirements for building spandrel panels are as follows:

- Softwood structural frame with vertical studs at 600mm centres
- Minimum section size 47 x 72mm where joints are plated and 38 x 89mm where joints nailed
- The orientation illustrated is 47 x 72mm shown vertical for plating. When nailed, the section will be orientated flatwise
- Cladding to provide 60-minute fire resistance as specified in Approved Document B1 of Building Regulations

### Example

- A two-layer 12.5mm dry lining, with each layer staggered 600mm horizontally and vertically
- Fixed in accordance with the dry lining manufacturer's specification. Or other twin or single cladding solutions to achieve a 60-minute fire rating and required acoustic performance





# 05

## Single-skin cladding

fermacell Gypsum Fibreboard is an example of a single-skin cladding solution for spandrel panels.

One 15mm sheet of fermacell can replace two sheets of plasterboard on either side of the panel to achieve the fire and acoustic requirements of a spandrel panel.

### fermacell key features

- Provides 60-minute fire protection when tested to BS.476 pt 22 1987
- Meets acoustic requirements as referenced in Annex A1 of Robust Details Handbook
- Resistant to moisture penetration and impact damage, meaning plastic wrapping is not needed on-site
- Can be used with nail plated or nailed frames
- fermacell cladding may be fixed with fermacell screws or galvanised staples
- Within a panel, tight dry butted joints between fermacell sheets formed over studs are standard with no need for further treatment
- Where required, individual panels may be jointed on-site using the method shown in the drawing opposite

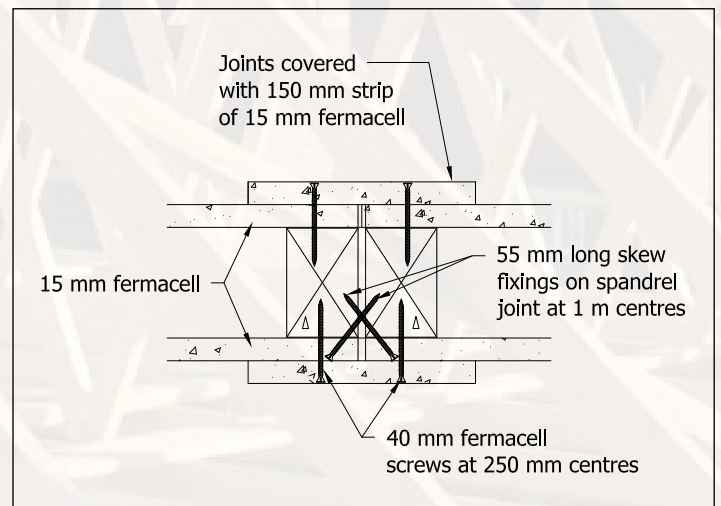
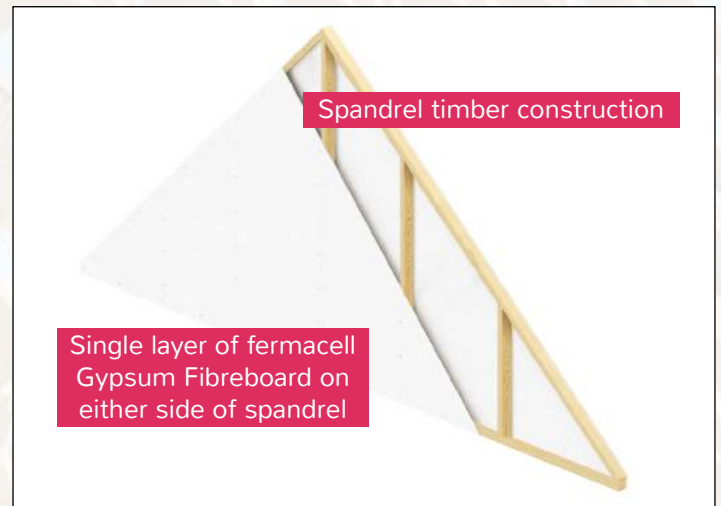

Spandrel panel joint details

Discover all the benefits and technical specs of fermacell single-skin cladding for spandrel panels.

Learn more at:

[www.fermacell.co.uk/TRASpandrel](http://www.fermacell.co.uk/TRASpandrel)

# 06 Weather protection

## Choice of cladding

The choice of cladding material and the planned time between delivery and roof covering will determine the weather protection required for the panel.

It will also determine the amount of work at height required on-site to allow for the removal of the weather protection.

Cladding such as plasterboard will always need full weather protection. Protective materials must be removed or vented once the roof covering is complete.

A more robust form of cladding with sufficient moisture resistance eliminates the need for additional site operations to remove weather protection, thereby reducing work at height risks and improving site safety.

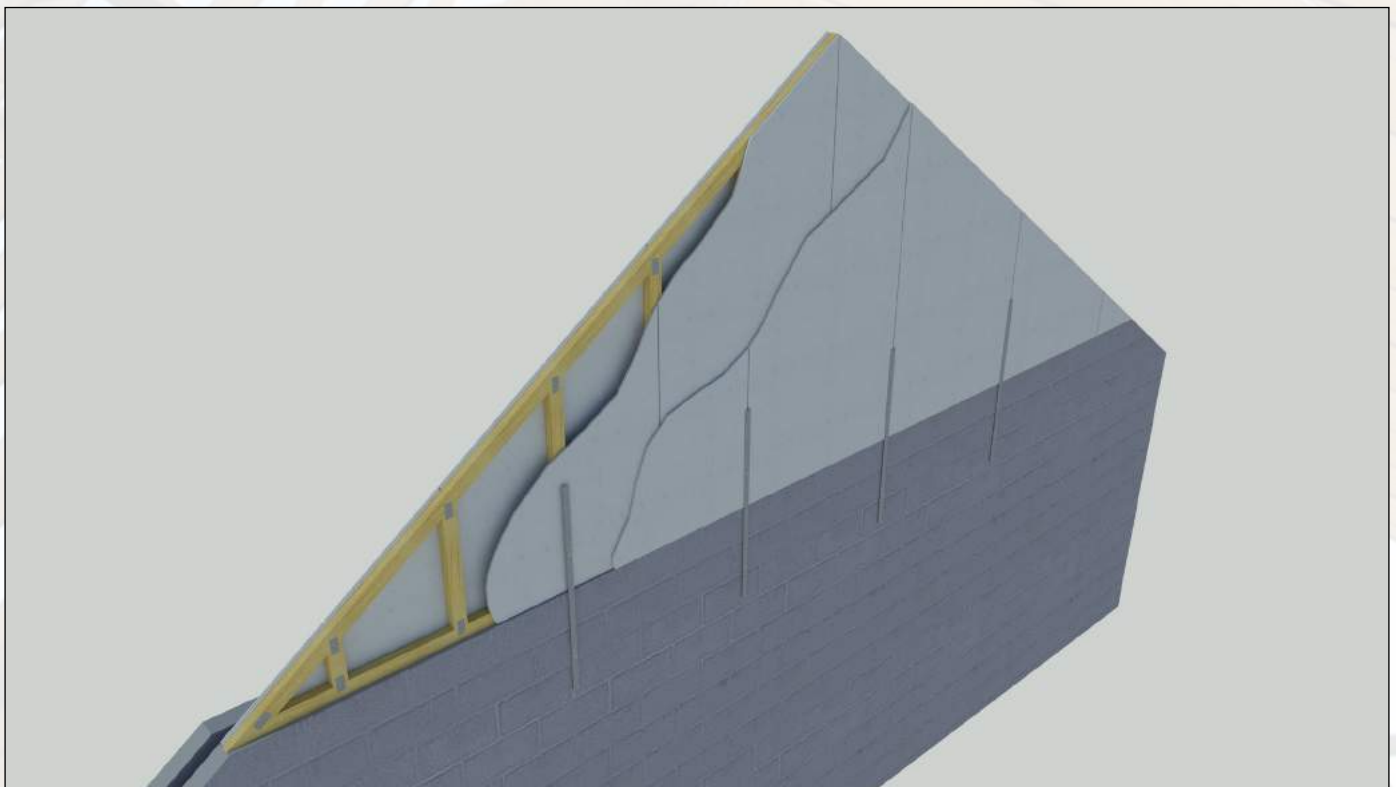



# 07

## Safe installation



### Installer obligations

Installers and contractors must provide full, site-specific risk assessments and method statements for the safe installation of party wall spandrel panels.

Further information on the safe unloading of spandrel panels on-site can be found at the TRA website.





Visit our website for more information:

[tra.org.uk](http://tra.org.uk)



The Building Centre  
26 Store Street  
London  
WC1E 7BT

T: 020 3205 0032  
E: [info@tra.org.uk](mailto:info@tra.org.uk)

The latest version of this guide can be  
downloaded online at [tra.org.uk](http://tra.org.uk)

All information is correct at the date this  
guide was produced. We reserve the right to  
make technical changes at any time.

